

CONNECT / MONITOR / CONTROL

EnergyTrak™ Install and User Manual for Pros

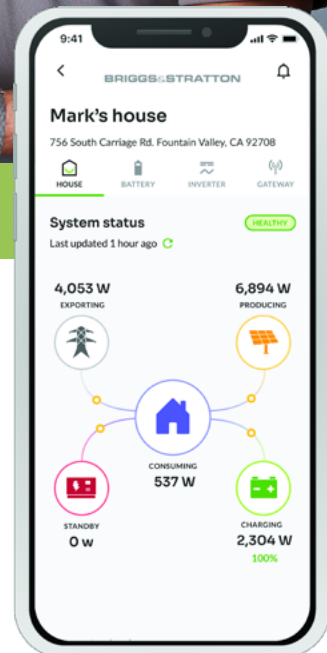











BRIGGS&STRATTON

Table of Contents

Important Safety Instructions _____	2
Warranty Statement _____	3
Energy Solutions Product Compatibility _____	4
Site Network and Internet Requirements _____	5
Getting Started with EnergyTrak for Pros _____	6
EnergyTrak Gateway Installation _____	7
EnergyTrak for Pros _____	9
SimpliPHI ESS Commissioning with EnergyTrak _____	12

Important Safety Instructions

Symbol	Meaning	Symbol	Meaning
	Safety alert symbol shows a possible personal injury hazard or damage to the system.		Chemical Burn
	Read Manual. Failure to obey warnings, instructions, installation manual, and Operator's Manual could result in death or serious injury.		Toxic Fume
	Explosion		Eye Protection
	Electric Shock		Hot Surface
	Auto-Start		Rotating Parts
	Fire		

Safety Alert Symbol and Signal Words



This safety alert symbol identifies safety information about hazards that could result in personal injury or damage to the system. A signal word (**DANGER, WARNING, or CAUTION**) is used to indicate the likelihood and the potential severity of injury. In addition, a hazard symbol is used to represent the type of hazard.

DANGER indicates a hazard which, if not avoided, **will** result in death or serious injury.

WARNING indicates a hazard which, if not avoided, **could** result in death or serious injury.

CAUTION indicates a hazard which, if not avoided, **could** result in minor or moderate injury.

NOTICE indicates information considered important but not hazard-related.

Warranty Statement

The following abbreviated guidelines do NOT encompass all EnergyTrak Warranty details. Failure to adhere to the Warranty and Installation Manual requirements will violate the terms of the Warranty. Read the complete Warranty and Installation Manual related to EnergyTrak and its connected Energy Solutions products (i.e., SimpliPHI™ Energy Storage System) prior to installation, which can be found at www.briggsandstratton.com.



Energy Solutions Product Compatibility

SimpliPHI Energy Storage System (ESS)

This manual is written for EnergyTrak installations with the SimpliPHI ESS using one (1) SimpliPHI 6kW Inverter and up to the maximum number of SimpliPHI 4.9kWh Batteries supported by a single inverter. For parallel inverter installations of SimpliPHI ESS, contact our Pro Technical Support at 800-759-2744.



>>> **NOTICE:** Using the instructions in this manual to connect the EnergyTrak Gateway to a SimpliPHI ESS parallel inverter installation, and using the EnergyTrak platform to configure or control that system, can result in undesired inverter configuration and operation, including damage to the system. Doing so may violate the terms of the warranty. Only use this manual for EnergyTrak with single inverter installations.



Site Network and Internet Requirements

General Network & Internet Requirements

At the site of installation, the system owner is responsible for providing an internet connection to the EnergyTrak Gateway using one of the following:

- Hardwired network connection using an ethernet cable (RECOMMENDED), or
- WiFi network connection with a strong signal at the location of the EnergyTrak Gateway.

All network equipment associated with connecting the EnergyTrak Gateway to the Internet (i.e., router, modem, network switches) should be powered from the critical loads panel so that these systems maintain operation in all power scenarios.

Hardwired Network Requirements (recommended)

A hardwired network connection to the EnergyTrak Gateway requires:

- Available Ethernet port for the Gateway to connect to the local area network, and
- A Cat-5e or Cat-6 ethernet cable (100 meters or less in length).

WiFi Network Requirements

A WiFi network connection to the EnergyTrak Gateway requires:

- Frequency band of either 2.4 or 5 GHz, and
- Adequate signal strength at the installed location of the EnergyTrak Gateway.

>>> An internet connection is REQUIRED for using EnergyTrak with the SimpliPHI ESS.

>>> **NOTICE** An unreliable WiFi network connection can disrupt timely firmware updates, which could lead to critical system failures. It is important that owners maintain the WiFi network being used to connect EnergyTrak to the Internet.



Getting Started with EnergyTrak for Pros

Creating Your Company's First Pro User Account

>>> **Complete this initial step well in advance of your first SimpliPHI ESS installation.**

To begin using the EnergyTrak Mobile App as a Pro, you will need to create your company's first Pro user account: a Pro Admin. For improved security, creating your first Pro Admin account is controlled by Briggs & Stratton.



In order to create your first Pro Admin account, contact Briggs & Stratton at 800-759-2744 or energytrak@basco.com.

This manual step is only required to create your first Pro Admin account. You will then be able to use that account to create additional Pro Admin users and Pro Technician users (more information on user types in the below section titled EnergyTrak for Pros). Once your Pro Admin account has been created, you will receive instructions via email for logging in to your account on the EnergyTrak app.

EnergyTrak Gateway Installation

Installation Diagram

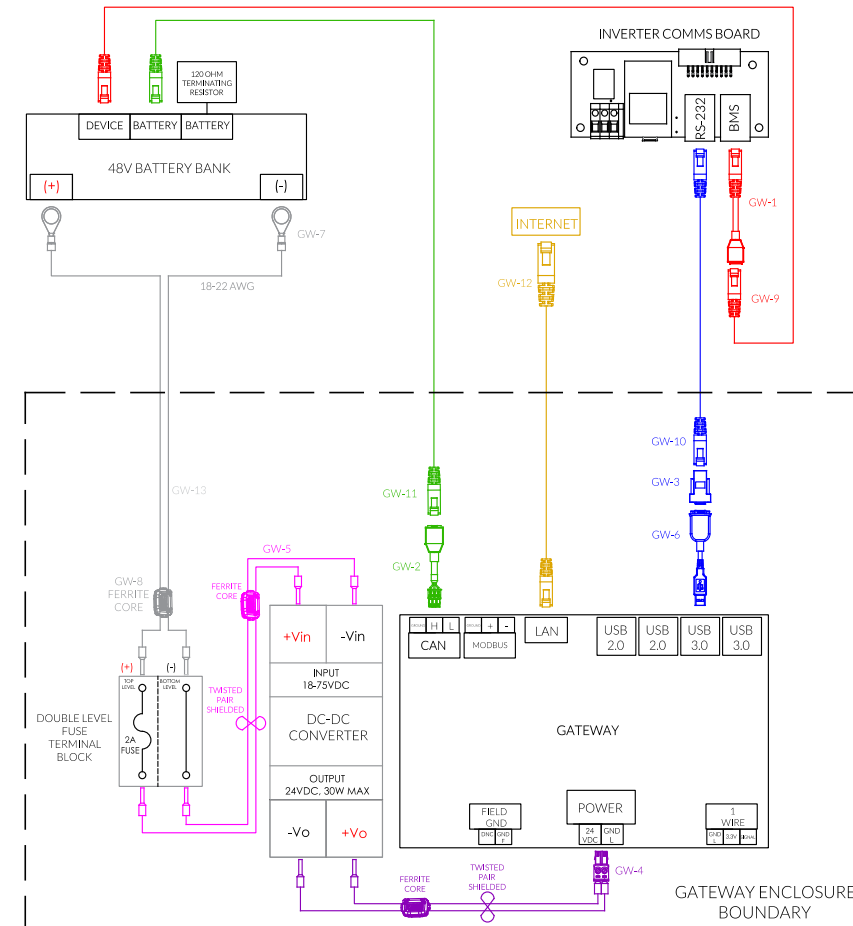

>>> **WARNING:** Connecting the EnergyTrak Gateway to the SimpliPHI ESS requires physical contact with the SimpliPHI 6kW Inverter and SimpliPHI 4.9kWh Battery that could result in shock or serious injury. Follow proper safety precautions as laid out in the SimpliPHI 6kW Inverter Installation Manual and SimpliPHI 4.9kWh Battery Installation Manual.



Required Cables and Adapters

Included with the EnergyTrak Gateway

- GW-1 Crossover Cable Adapter
- GW-2 CAN to RJ45 Adapter
- GW-3 DB9 to RJ45 RS-232 Adapter
- GW-4 Gateway Power Cables (pre-installed)
- GW-5 Fuse DC Jumper Cable (pre-installed)
- GW-6 USB to DB9 RS-232 Adapter
- GW-7 Battery Power Ring Terminals (two (2) units)
- GW-8 Ferrite Core for GW-13

Not Included (Customer Provided)

- GW-9 Battery CAN Bus Ethernet Cable (Cat-5e or Cat-6)¹
- GW-10 Inverter RS-232 Ethernet Cable (Cat-5e or Cat-6, 30 meters or less)
- GW-11 Inverter CAN Bus Ethernet Cable (Cat-5e or Cat-6, 100 meters or less)
- GW-12 Local Area Network Ethernet Cable (Cat-5e or Cat-6, 100 meters or less)
- GW-13 Battery to Gateway Electrical Wires (two (2) wires, 18 AWG, shielded grounded twisted pair)

¹ The overall length of all ethernet cables used across the entire battery bank CAN bus cannot exceed 100 meters; this includes the ethernet cable (GW-8) between the EnergyTrak Gateway and the Battery it is connected to, and all ethernet cables running from battery to battery (not pictured here)



Gateway Enclosure Conduit Entry Points

1. Entry points for cabling should be drilled into the flat surface plane on the top of the gateway enclosure and/or the upper sides of the gateway enclosure. Use the visual diagrams in this section for more specific guidance on proper entry point locations.
2. It is recommended to drill the fewest possible entry points to accommodate the required cabling based on the specific installation.
3. Use the appropriate conduit fittings for the installation to maintain the outdoor rating per local AHJ (authority having jurisdiction).

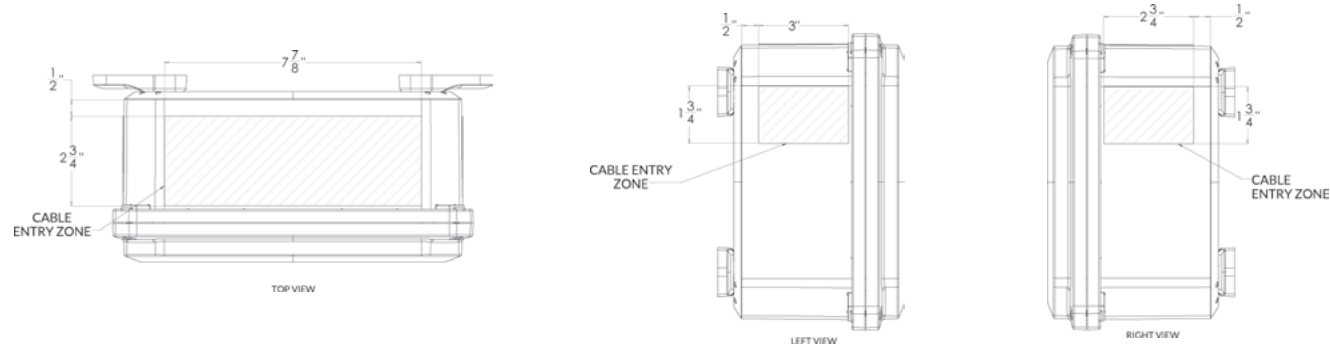

Wiring Install Instructions

4. Connect GW-1 to the RJ45 port labeled BMS on the SimpliPHI 6kW Inverter.
5. Connect one end of GW-9 to the RJ45 port on GW-1 and the other end to the RJ45 port labeled DEVICE on one of the SimpliPHI 4.9kWh Batteries. If there are multiple batteries installed in parallel, the installer can connect this to the port on any of the batteries.
6. Connect the 3 position connector on GW-2 to the CAN port on the EnergyTrak Gateway.
7. Connect one end of GW-11 to the RJ45 port on GW-2 and the other end to one of the two open RJ45 ports labeled BATTERY on the battery bank. An available RJ45 terminator should be installed in the other open RJ45 port labeled BATTERY on the battery bank.
Note: In a multiple-battery daisy chain install, the RJ45 terminator should be installed in the open BATTERY port at one end of the daisy chain and GW-2 in the open BATTERY port at the other end of the daisy chain.
8. Connect GW-3 to GW-6 using the DB9 connectors.
9. Connect GW-6 to any of the four open USB ports on the EnergyTrak Gateway.
10. Connect one end of GW-10 to GW-3 and the other end to the RJ45 port labeled RS-232 on the SimpliPHI 6kW Inverter.
11. If disconnected during installation, connect the 2 position connector on GW-4 to the POWER port on the EnergyTrak Gateway.
12. If disconnected during installation, connect the black wire on GW-4 to the -Vin port on the DC-DC power supply unit.
13. If disconnected during installation, connect the red wire on GW-4 to the +Vin port on the DC-DC power supply unit.
14. Connect one end of GW-12 to the Ethernet/LAN port on the EnergyTrak Gateway and the other end to an open port on the site's network switch or router (customer owned). NOTE: Verify with the site owner that the port on the site's network switch or router can provide Internet access to the Gateway. This step is optional if using WiFi to connect the EnergyTrak Gateway to the Internet.
15. Ensure GW-5 is securely installed between the fuse terminal block and the DC-DC power supply unit. This wire was pre-installed prior to shipping.
16. Connect GW-7 ring terminals onto the GW-13 electrical wires. It is recommended to use one red wire and one black wire for easy identification of the DC circuit.
17. Connect the red electrical wire assembly to the positive power terminal on the SimpliPHI 4.9kWh Battery using the GW-7 ring terminal, and connect the other end to the top terminal port on the 3A Fuse Terminal Block.
18. Connect the black electrical wire assembly to the negative power terminal on the SimpliPHI 4.9kWh Battery using the GW-7 ring terminal, and connect the other end to the bottom terminal port on the 3A Fuse Terminal Block.
19. Attach the provided ferrite core (GW-8) around both of the GW-13 wires inside the gateway enclosure.

Once the SimpliPHI ESS and EnergyTrak Gateway installations are complete, proceed with setup in the EnergyTrak app. Review the following section for guidance on using EnergyTrak.

EnergyTrak for Pros

Installing the EnergyTrak Mobile App

You can download the EnergyTrak mobile app from the respective app store for your mobile device. Scan the QR code below from your mobile device for easy access! You can also navigate to www.energytrak.app/mobile in your browser for quick forwarding to the app store for your device

Alternatively, you can search "EnergyTrak" in the respective app store to find and install the app.

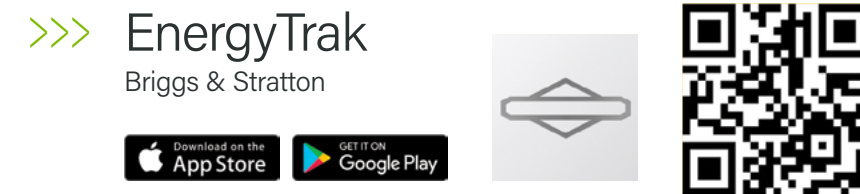

User Creation and Management

Users can be managed and created from the Users screen in the EnergyTrak Mobile App. User account types include:

Pro Admins

With the most permissions available to Pro users, Pro Admins have the ability to:

- Create and manage users, including Pro Admins, Pro Technicians, and System Owners
- Create and manage customer sites
- Add or remove sites to Pro Technician user accounts
- Setup new products
- Reconfigure installed products
- View all customer sites under their business
- Receive notifications for all registered sites

Pro Technicians

Designed for Pro users who are working with customer products every day, Pro Technicians have a streamlined feature set to help them focus on what needs to get done:

- Create new sites
- Create new System Owner users (during commissioning only)
- Setup new products
- View assigned customer sites
- Reconfigure installed products at assigned customer sites
- Receive notifications from assigned customer sites

System Owners

For users purchasing an EnergyTrak-enabled product and installing it at their site, System Owners get the information and control they need over their site and installed products, including:

- View site and product details
- Control installed products
- Change WiFi network settings
- Receive notifications from registered sites



Site Fleet Tracking

Pro users can monitor the status of their customer sites from the Sites screen in the EnergyTrak app. Each site has a status that indicates its current operating state, including:

Healthy: All systems are functional and normal

Warning: Some non-essential systems have been lost, but no reported critical failures

Critical: Essential failures with a system have been detected

Ready for Setup: The site has been created but no products have been set up

Deactivated: Site has been unregistered from the EnergyTrak platform

The Sites screen is also where Pro users can create new Sites for new installations.

Site Dashboard

The Site Dashboard will show a summarized view of the site's connected products, the systems related to the configuration, and the EnergyTrak Gateway.

From this screen, Pro users are able to view greater detail about and remotely edit the configuration of the installed products for any site registered to their account.

For safety reasons, System Owner users have limited ability to edit the configuration of the ESS. They do have the ability to edit network settings of the EnergyTrak Gateway (i.e., WiFi network settings) and toggle the time-of-use (TOU) settings OFF/ON. An owner may want to temporarily turn off TOU settings if they expect a disruption to their grid power availability (i.e., encroaching storm) and prefer to reserve the stored battery power for backup needs.

Change Configuration

The Change Configuration feature allows users to adjust settings at a specific Site related to EnergyTrak and the connected products. This capability can be accessed from the Change Configuration button found on the Site Dashboard. A particular user can only access this feature on sites which they are registered to.



SimpliPHI ESS Commissioning with EnergyTrak

Before You Start

There are several preparations and pieces of information to collect before you start commissioning the SimpliPHI ESS from the EnergyTrak app.

SimpliPHI ESS Install

Ensure your SimpliPHI ESS has been properly installed as outlined in the SimpliPHI 6kW Inverter Installation Manual and SimpliPHI 4.9kWh Installation Manual.

Gateway Install

Ensure the EnergyTrak Gateway has been installed properly as outlined in the section above titled EnergyTrak Gateway Installation.

WiFi Info (optional)

If using a WiFi network connection to connect the EnergyTrak Gateway to the Internet, confirm the WiFi network credentials (network name/SSID and password) for the site's network.

WARNING: An unreliable wireless network connection can disrupt timely firmware updates, which could lead to critical system failures. Therefore, Briggs & Stratton does not recommend the use of a wireless connection.

Gateway Proximity

Ensure you are within Bluetooth range (10 feet) of the EnergyTrak Gateway.

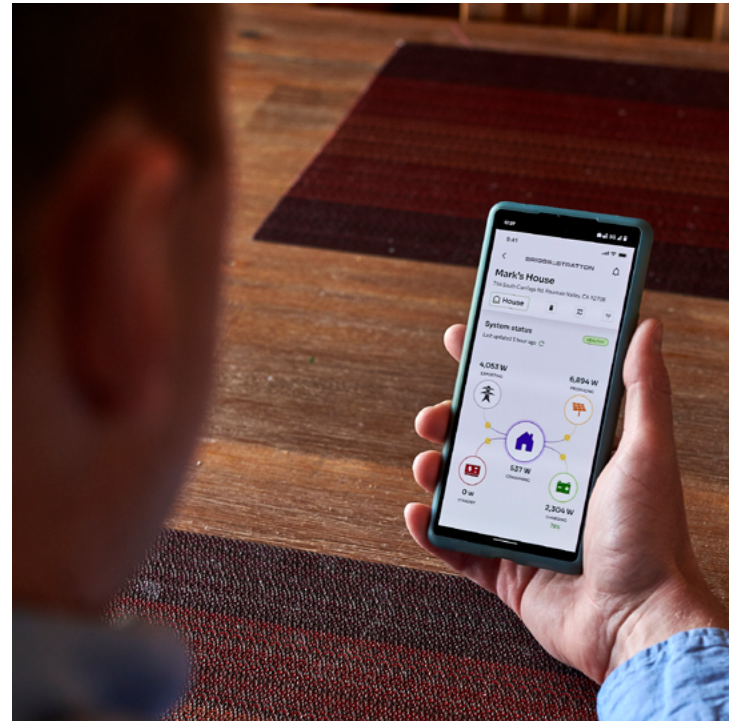

Grid Profile

Confirm the appropriate "Grid Profile" that should be set in the SimpliPHI 6kW Inverter based on the installation. Options include IEEE 1547 Default or Off-Grid.

Operating Profile

Confirm the appropriate "Operating Profile" that should be set in the SimpliPHI 6kW Inverter based on the installation. See the section below titled Choose Operating Profile for more details.

Site Info

The SimpliPHI ESS will be registered to a Site within EnergyTrak. To create a new site, you will need:

- Site name
- Street address
- City
- State
- Zip code

A new Site can be created at any time prior to commissioning the system.

System Owner Info

Towards the end of commissioning, you can optionally create a System Owner user account to help simplify the owner's use of EnergyTrak and their new SimpliPHI ESS (recommended). Confirm the owner's full name, email address, and phone number in order to complete this.

Mobile Device Battery Level

To ensure the commissioning process is not interrupted, ensure the mobile device being used to perform commissioning in the EnergyTrak app has at least 50% battery level.

SimpliPHI 4.9kWh Battery Charge Level

Ensure that the connected battery (or batteries) have at least a 30% charge level (SoC) prior to beginning. This ensures that critical processes are not interrupted due to a loss of power.



Create a New Site

To create a new Site, navigate to the Sites list and press the CREATE NEW SITE button at the bottom of the screen.

More information: Before you are able to commission the SimpliPHI ESS using the EnergyTrak app, you will first need to create a new Site in the app. A Site represents the physical location where the product is being installed (typically, a residence or a business).

Start Commissioning

Before you are able to commission the SimpliPHI ESS using the EnergyTrak app, you will first need to create a new Site in the app. A Site represents the physical location where the product is being installed (typically, a residence or a business).

Establish Power to the Inverter

Before continuing further, establish power to the inverter (and turn on the batteries, if applicable) at this time.

The app provides an abbreviated walkthrough on how to do this. However, technicians who are new to the SimpliPHI ESS are encouraged to review the more detailed guide provided in the SimpliPHI 6kW Inverter Installation Manual and SimpliPHI 4.9kWh Installation Manual. This walkthrough can optionally be skipped by clicking the SKIP THE INSTRUCTION button.

Connect to Gateway over Bluetooth

Select the appropriate Bluetooth network from the list for the EnergyTrak Gateway that was installed, and then press the CONTINUE button. If prompted by the mobile device, be sure to allow both the Bluetooth connection and location services.

More information: EnergyTrak uses a Bluetooth connection between the EnergyTrak Gateway and the mobile device running the EnergyTrak app. The Bluetooth list will show all available Bluetooth networks that are in range of the mobile device. The name of the gateway's Bluetooth network matches its ID#, which is printed on the label of the gateway.

Equipment Details

Ensure the proper inverter and battery quantities are detected.

More information: The EnergyTrak Gateway will automatically search for and detect the compatible equipment which is (a) powered ON and (b) properly connected to the gateway. The Equipment Details screen will show the SimpliPHI 6kW Inverter and SimpliPHI 4.9kWh Battery (or Batteries) it is able to detect.

Update Firmware

If the firmware files on the inverter or battery are up-to-date, press the CONTINUE button (it will be the only button shown).

If the firmware files on the inverter or battery need to be updated, press the UPDATE FIRMWARE button (it will be the only button shown) to begin the update process. Press the CONTINUE button once the firmware has finished updating.

More information: The EnergyTrak mobile app stores and maintains the current firmware files for the SimpliPHI 6kW Inverter and SimpliPHI 4.9kWh Battery. When the Equipment details screen opens, EnergyTrak will automatically check the current version of the firmware files in the app with the version of the firmware files currently installed on the inverter and battery.

Firmware Upload to Gateway

The mobile app will first transfer the firmware files from the mobile device to the gateway using the Bluetooth connection. Please allow up to two minutes for the transfer to be completed. BE SURE TO REMAIN IN BLUETOOTH RANGE UNTIL THIS IS COMPLETED.

Firmware Update to Inverter and/or Battery

Once the files have been transferred to the gateway, updating of the inverter and battery will begin using the hardwired connection between the gateway and the devices. This process takes about two minutes per battery and 30 minutes per inverter. This process is NOT reliant on the Bluetooth connection between the mobile device and the gateway, so it is okay to take the mobile device out of Bluetooth range (go get a snack!).

If the mobile device leaves Bluetooth range once the gateway has begun updating the firmware on the inverter and/or battery, the firmware update process will continue between the EnergyTrak Gateway and the SimpliPHI ESS.



Choose Grid Profile

Select the appropriate Grid Profile and then press the CONTINUE button.

More information: The “Grid Profile” is a selection made during commissioning the SimpliPHI ESS in EnergyTrak which defines specific operating parameters of the SimpliPHI 6kW Inverter, ensuring the system is compliant and interoperable with the site’s electric utility. Select either IEEE 1547 Default or Off-Grid, depending on the application.

Choose Operating Profile

Select the appropriate Operating Profile and then press the CHOOSE PROFILE button.

More information: The “Operating Profile” is a selection made during commissioning the SimpliPHI ESS in EnergyTrak which acts like an “easy button” for getting the system online. Each operating profile has a pre-defined template of settings that are applied to the SimpliPHI 6kW Inverter. Most of these settings can be customized prior to completing the commissioning process. See the section below for more information related to Operating Profiles.

If you select the Grid-Tied Backup profile, you will be prompted to optionally define the desired time-of-use settings. Follow the on-screen instructions to complete this section.

Note: If you selected the Off-Grid Grid Profile in the previous menu, then the system will default to the Off-Grid Operating Profile and you will skip this step.

Operating Profile Descriptions

Grid-Tied Backup

Parameter	Setting
Solar Distribution Priority	Battery > Load > Grid
Enable Charging	Enabled
Enable AC Charging	Enabled
Enable feed to Utility	Enabled
Enable discharge to Load when PV present	Disabled
Enable discharge to Load when PV absent	Disabled

Grid-Tied Backup with Time-of-Use

Parameter	Setting
Solar Distribution Priority: On-Peak	Load > Battery > Grid
Solar Distribution Priority: Off-Peak	Battery > Load > Grid
Enable Charging	Enabled
Enable AC Charging	Enabled
Enable feed to Utility	Disabled
Enable discharge to Load when PV present	Enabled
Enable discharge to Load when PV absent	Enabled



Grid-Tied Zero Export

Parameter	Setting
Solar Distribution Priority	Load > Battery
Enable Charging	Enabled
Enable AC Charging	Enabled
Enable feed to Utility	Disabled
Enable discharge to Load when PV present	Enabled
Enable discharge to Load when PV absent	Enabled

Grid-Tied Solar

Parameter	Setting
Solar Distribution Priority	Grid
Enable Charging	Disabled
Enable AC Charging	Disabled
Enable feed to Utility	Enabled
Enable discharge to Load when PV present	Disabled
Enable discharge to Load when PV absent	Disabled

Off-Grid

Parameter	Setting
Solar Distribution Priority	Load > Battery
Enable Charging	Enabled
Enable AC Charging	Disabled
Enable feed to Utility	Disabled
Enable discharge to Load when PV present	Enabled
Enable discharge to Load when PV absent	Enabled

Summary and Edit Configuration

Review the listed settings on the Summary screen and verify these are the correct settings to apply to the inverter.

When the configuration parameters for the SimpliPHI ESS are ready to be set, press the DONE button to continue with the EnergyTrak setup.

More information: The summary screen will show a high-level view of the settings which will be applied to the SimpliPHI 6kW Inverter once complete. If you would like to change any of the inverter's parameters, press the corresponding EDIT button for configuration options within that section. See the following section of this manual titled Edit Configuration Details for more information.

Note: Only a select subset of the SimpliPHI 6kW Inverter configuration parameters are available in EnergyTrak. The "source of truth" for these settings resides in EnergyTrak, and changes made to these settings outside of EnergyTrak (i.e., from the front panel on the inverter) will be overwritten. It is important to only change these settings within the EnergyTrak app. See the complete list of EnergyTrak settings below.

To change settings which are not available in EnergyTrak, you will need to use the LCD panel on the front of the inverter. Refer to the SimpliPHI 6kW Inverter Installation Manual and SimpliPHI 4.9kWh Installation Manual for more information.

EnergyTrak SimpliPHI 6kW Inverter Settings

- Grid Profile
- Max Charge Current
- Max AC Charge Current
- Bulk Charge Voltage
- Float Charge Voltage
- LBCO When Grid is Available
- LBCO When Grid is Unavailable
- Max Discharge Current in Hybrid Mode
- Grid Monitoring/Reconnect Time
- Max Power to Grid
- Load Output
- Generator as Power Source
- Buzzer/Alarm
- Mute Alarm in Standby Mode
- System Date
- System Time
- Solar Distribution Priority
- Enable Charging
- Enable AC Charging
- Enable feed to Utility
- Enable discharge to Load when PV present
- Enable discharge to Load when PV absent
- AC Charge Time Window
- AC Support Load Time Window



Add System Owner

Enter the required information for the System Owner and press the ADD button. This will create a new EnergyTrak System Owner user account.

More information: If the email address is NOT associated with an existing EnergyTrak account, an email invitation will be sent to the provided email address (from energytrak@basco.com). It is recommended to confirm that the customer received the email before completing the job.

If the email address is already associated with an EnergyTrak account, you must skip this step and add the System Owner from the Site Dashboard screen once commissioning is complete.

Even though this is an optional step during the commissioning process, adding a system owner to the site must be completed before the owner can associate the SimpliPHI ESS with their EnergyTrak account and see it in the EnergyTrak app.

Connect Gateway to the Internet

If the EnergyTrak Gateway has already been connected to the Internet using a hardwired Ethernet cable connection, then this step can be skipped. Optionally, the WiFi network connection can also be set up as a redundant connection to the Ethernet connection.

If using WiFi as the primary network for the Internet connection (NOT RECOMMENDED), this step should NOT be skipped.

To set up the WiFi network connection, select the appropriate WiFi network from the list, press CONNECT, enter the network's password, and then press the JOIN button.

Note: EnergyTrak requires an Internet connection to operate. Establishing an Internet connection to the EnergyTrak Gateway does rely on the site's local network and its Internet connection. This requires the system owner to provide and maintain a healthy, reliable network and Internet connection for EnergyTrak. See the section above titled Site Network and Internet Requirements for specific requirements.

WARNING: An unreliable wireless network connection can disrupt timely firmware updates, which could lead to critical system failures. Therefore, Briggs & Stratton does not recommend the use of a wireless connection.

Setup Confirmation

Setup complete! At this time, the EnergyTrak Gateway should be connected to the Internet, and the SimpliPHI ESS should be working as configured.

The site should be viewable from the Sites screen in the EnergyTrak app, and the status of the site should be HEALTHY unless something needs to be addressed. Selecting the site will show the Site Dashboard with a detailed view of the current power flow through the SimpliPHI ESS.

The Site Dashboard and Change Configuration features can be used to view and validate the settings which have been applied to the system, including details about the SimpliPHI ESS. Pros are highly encouraged to review this detail and validate the system's operation prior to completing their work.

Troubleshooting

At this point, if the SimpliPHI ESS is producing any faults, or the system is not operating as intended, the technician should troubleshoot the system using the self-help resources available. Technical Support from Briggs & Stratton is also available to assist technicians with troubleshooting. The Help screen in the EnergyTrak app (found in the primary menu) includes links to resources and contact information for Technical Support, if needed.

